

Linear DC-Servomotors

9,2 N

for sin/cos control
QUICKSHAFT® Technology

Series LM 2070 ... 12

	LM 2070-	040-12	080-12	120-12	160-12	220-12	
1 Continuous force ¹⁾	$F_e \text{ max.}$	9,2					N
2 Peak force ^{1) 2)}	$F_p \text{ max.}$	27,6					N
3 Continuous current ¹⁾	$I_e \text{ max.}$	0,79					A
4 Peak current ^{1) 2)}	$I_p \text{ max.}$	2,37					A
5 Back-EMF constant	k_E	9,5					V/m/s
6 Force constant ³⁾	k_F	11,64					N/A
7 Terminal resistance, phase-phase	R	10,83					Ω
8 Terminal inductance, phase-phase	L	1 125					μH
9 Stroke length	$s_{\text{max.}}$	40	80	120	160	220	mm
10 Repeatability ⁴⁾		100	100	100	100	120	μm
11 Precision ⁴⁾		500	600	700	800	900	μm
12 Acceleration ⁵⁾	$a_e \text{ max.}$	93,9	65,7	54,8	46,0	36,8	m/s^2
13 Speed ^{5) 6)}	$v_e \text{ max.}$	1,9	2,3	2,6	2,7	2,8	m/s
14 Thermal resistance	R_{th1} / R_{th2}	3,1 / 9,3					K/W
15 Thermal time constant	τ_{w1} / τ_{w2}	30 / 1 200					s
16 Operating temperature range		- 20 ... +125					$^{\circ}\text{C}$
17 Rod weight ⁷⁾	m_m	98	140	168	200	250	g
18 Total weight ⁷⁾	m_t	236	278	306	338	388	g
19 Magnetic pitch	τ_m	24					mm
20 Rod bearings		polymer sleeves					
21 Housing material		metal, non-magnetic					
22 Direction of movement		electronically reversible					

¹⁾ thermal resistance R_{th2} by 55% reduced

²⁾ for max. 1 second with a duty cycle of 10%

³⁾ with sine wave commutation

⁴⁾ typical values with integrated linear Hall sensors (sin/cos) and Motion Controller Elmo "Whistle" SOL-WHI2.5/60I01.

The values depend on conditions of use

⁵⁾ theoretical value, referring only to the motor

⁶⁾ with a triangular speed profile and the max. stroke

⁷⁾ rounded value, for reference only

Notes: These motors are for operation with DC-voltage < 75 V DC.

The given values are for free standing motors.

The mounting with magnetic conductive metal can influence the characteristics of the motor.

For more information about drive electronics, please contact your local sales representative.

Caution: Presence of strong magnetic fields. Static sensitive device.

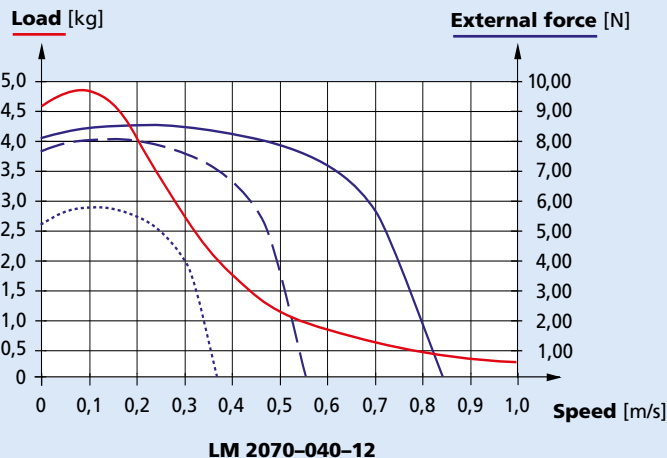

Trapezoidal motion profile ($t_1 = t_2 = t_3$)

Displacement distance:	40 mm
Friction coefficient:	0,2
Slope angle:	0°
Rest time:	0,1 s

Load: The max. permissible load at a given speed with an external force of 0 N

External force: The max. permissible external force at a given speed with a load of:

- 0,5 Kg —————
- 1,0 Kg - - - - -
- 2,0 Kg ·········

Linear DC-Servomotor LM 2070 ... 12 with axial connection

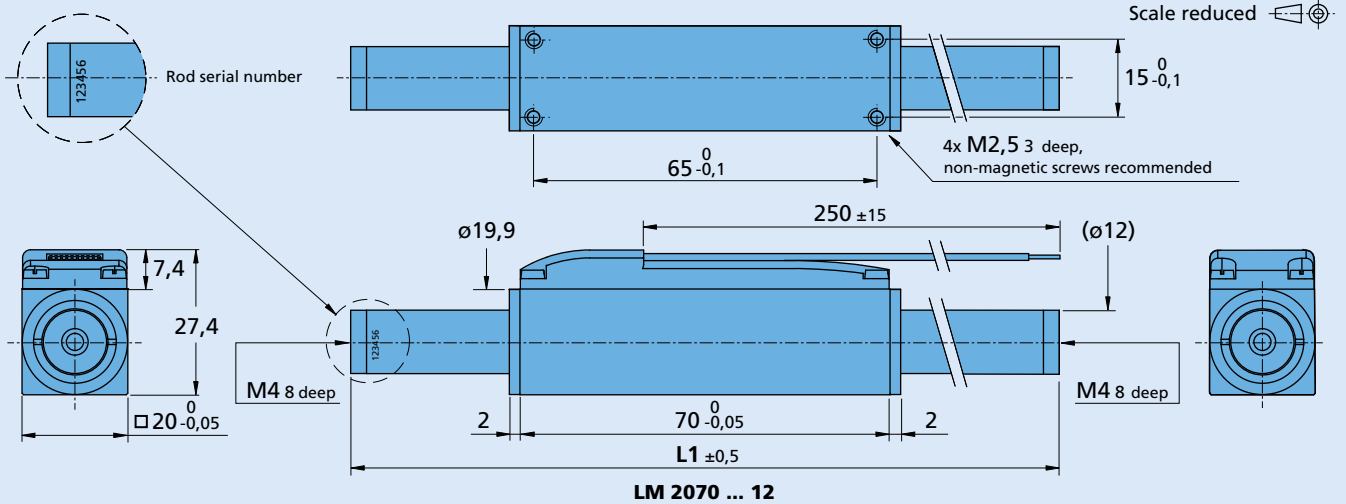

Ordering information

Linear DC-Servomotors Series

Stroke mm

Rod length L1 ±0,5 mm

Series	Stroke mm	Rod length L1 ±0,5 mm
LM 2070-040-12	- 20 0 + 20	134
LM 2070-080-12	- 40 0 + 40	182
LM 2070-120-12	- 60 0 + 60	218
LM 2070-160-12	- 80 0 + 80	254
LM 2070-220-12	- 110 0 + 110	314

Note: Single rod available on request.

Cable and connection information

Cable for LM 2070-...-12C

Material PVC, 10 conductors, AWG 28 with connector A05a - TCO, pitch 2 mm

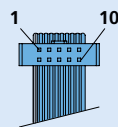
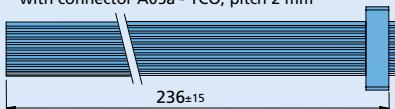

Cable for LM 2070-...-12

Material PVC, 10 conductors, AWG 28, grid 1mm, wires tinned

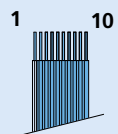
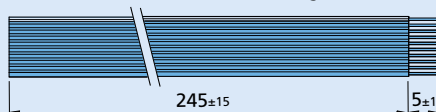

Cable for LM 2070-...-02

Single wires, material PVC, 10 conductors, AWG 28. Recommended connector: Molex - Nr. 51110-1060

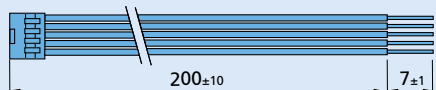

* The color reference refers only to the LM 2070-...-02 version.

Connection

LM 2070-...-02

PIN	Function	Color*
1	Phase C	yellow
7	Phase B	orange
8	Phase A	brown
4	GND	black
3	+5V	red
2	Sin +	green
5	Sin -	blue
6	Cos +	grey
9	Cos -	white
10	N.C.	purple

LM 2070-...-12 / 12C

PIN	Function
1	Phase C
2	Phase B
3	Phase A
4	GND
5	+5V
6	Sin +
7	Sin -
8	Cos +
9	Cos -
10	N.C.