



- **Direct drive – backlash free**
- **Integrated Absolute Encoder**
- **Microradian resolution**
- **No power draw in hold position**
- **Quick response**

The LR17 is a high precision motor in the second generation of Piezo LEGS Rotary. It is intended for a large range of applications where high speed dynamics and positioning with precision is crucial. High torque output in a small package is also beneficial.

The Piezo LEGS technology is characterized by its outstanding precision. Fast speed and quick response time, as well as long service life are other benefits. In combination with the micro radian resolution the technology is quite unique.

The motor is ideally suited for move and hold applications or for automatic adjustments. When in hold position it does not consume any power. The drive technology is direct, meaning no gears are needed to create motion. The motor has no mechanical play or backlash.

The motor comes with an integrated high resolution magnetic encoder. Feedback from the encoder gives resolution of 0.2 mrad (0.01°) in closed loop operation. The open loop resolution of the motor is 0.1 μrad (0.000006°).

Operating modes

The motor can move in full steps (waveform-steps), or partial steps (microsteps) giving positioning resolution in the microradian range. Speed is adjustable from microsteps per second up to max specified. The motor can be operated with feedback from the integrated magnetic encoder to form a closed loop system.

Controlling the motor

PiezoMotor offers a range of drivers and controllers. The most basic one is a handheld push button driver. Another option is an analogue driver that regulates the motor speed by means of an ±10 V analog interface. More advanced alternatives are microstep drivers/controllers in the 100- and 200-series. These products allow for closed loop control and precise positioning. The microstepping feature divides the wfm-step into thousands of small increments which results in microsteps in the microradian range. The PMD units are straight forward to use, supports quadrature and serial sensors, and have multiple I/O ports.



PMD101



PMD206

Design your own driver

Some customers prefer to design their own driver for ease of integration. PiezoMotor provides information to assist in the design.

Ordering information

Motor

LR17	Standard version
------	------------------

Drivers and Controllers

PMCM31	Analogue driver
PMD101	1-axis microstepping driver
PMD206	6-axis microstepping driver
PMD236	36-axis microstepping driver

Operating Principle

The Piezo LEGS walking principle is of the non-resonant type, i.e. the position of the drive legs is known at any given moment. This assures very good control of the motion over the whole speed range.

The performance of a Piezo LEGS motor is different from that of a DC or stepper motor in several aspects. A Piezo LEGS motor is friction based, meaning the motion is transferred through contact friction between the drive leg and the drive disc. You cannot rely on each step being equal to the next. This is especially true if the motor is operated under varying torques, as shown in the diagram below. For each waveform cycle the Piezo LEGS motor will take one full step, referred to as one *wfm-step* (~1.5 mrad at no load with waveform *Rhomb*). In the schematic illustrations to the right, you can see one step being completed. The rotational velocity of the drive axle is the *wfm-step* angle multiplied with the waveform frequency ($1.5 \text{ mrad} \times 2 \text{ kHz} = 3 \text{ rad/s} = 170 \text{ }^\circ/\text{s}$).

Microstepping is achieved by dividing the *wfm-step* into discrete points. The resolution will be a combination of the number of points in the waveform, and the torque. Example: at 15 mNm torque the typical *wfm-step* angle with waveform *Delta* is ~0.8 mrad, and with 8192 discrete points in the waveform the microstep resolution will be ~100 nrad (nano-radians).

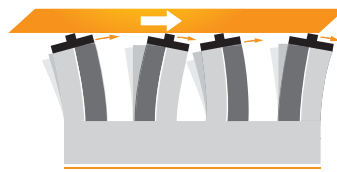

1 When all legs are electrically activated they are elongated and bending. As we shall see below, alternate legs move as pairs. Arrows show the direction of motion of the tip of each leg.

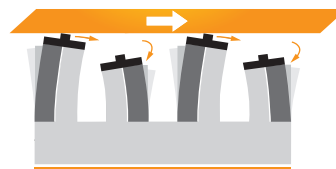

2 The first pair of legs maintains contact with the drive disc and moves towards the right. The second pair retracts and their tips begin to move left.

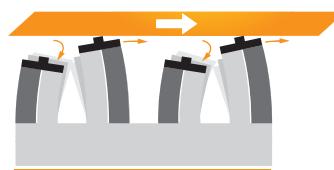

3 The second pair of legs has now extended and repositioned in contact with the drive disc. Their tips begin moving right. The first pair retracts and their tips begin to move left.

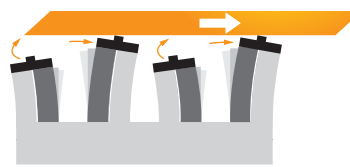

4 The second pair of legs has moved right. The first pair begins to elongate and move up towards the drive disc.

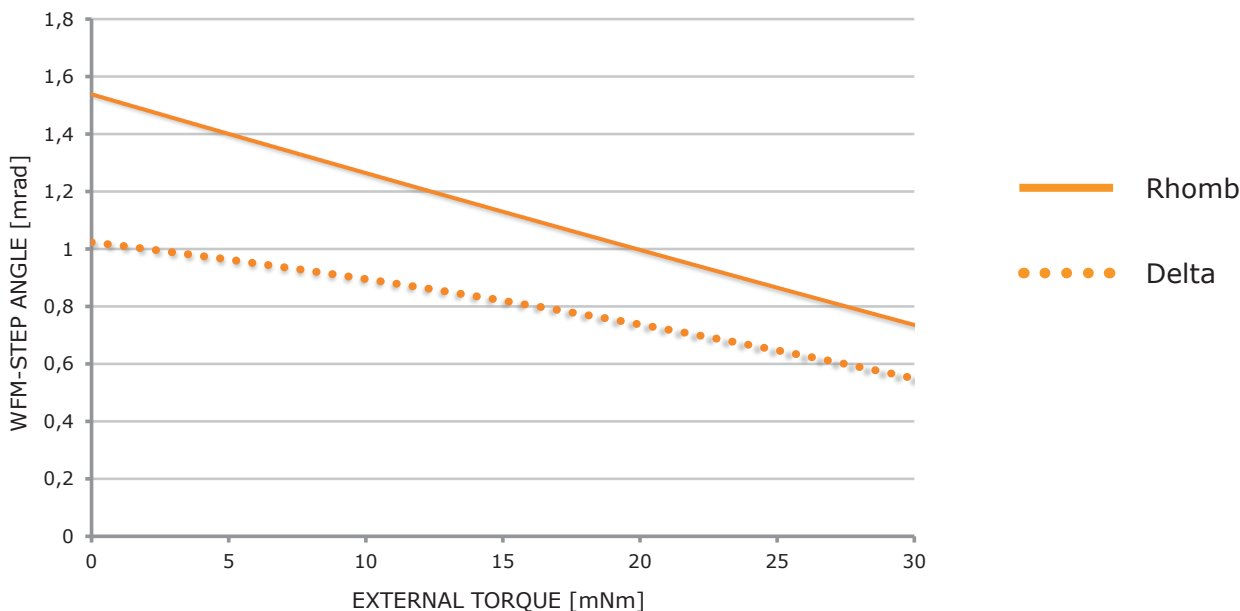
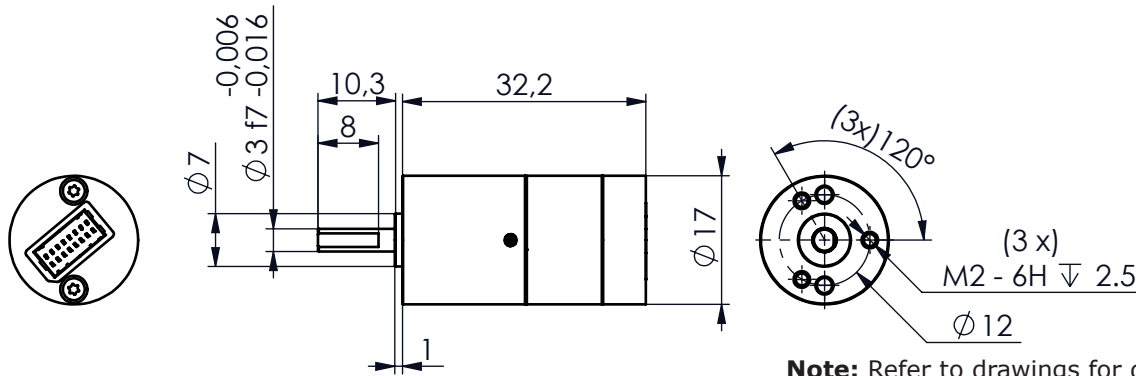

Figure 1 Motor performance with waveform *Rhomb* (filled) and waveform *Delta* (dotted). *Wfm-step* angle is the average distance the drive disc rotates when the legs take one *wfm-step* (i.e. for one waveform cycle). Note: Standard deviation σ of 0.1 mrad should be taken into account. Typical values are given for 20°C.

Main Dimensions LR17



Electrical Connector Type

The connector on the motor is a 16 pin dual row CviLux connector CI1116M2VD0, which mates with socket from the CviLux CI1116 family.

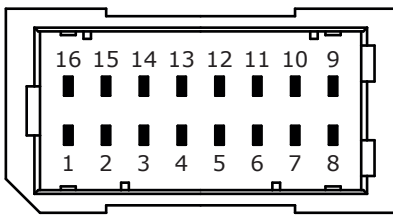

Pin Assignment

Pin	Terminal	Note
1	Sensor +5V/+3V3	
2	-	Do not connect
3	-	Do not connect
4	Motor Phase 3	
5	Motor Phase 4	
6	-	Do not connect
7	-	Do not connect
8	-	Do not connect
9	Motor Phase 2	
10	Motor Phase 1	
11	Sensor Data (SDA)	
12	Sensor Clock (SCK)	
13	-	Do not connect
14	Sensor Ground (GND)	
15	-	Do not connect
16	Motor Ground (GNDM)	

Encoder

The LR17 has an integrated magnetic absolute encoder. It gives 15 bit SSI data. SCK (Sensor Clock) and SDA (Sensor Data) are normally at high level (idle). When receiving a clock pulse from the controller, the LR17 will respond with position data. The SCK frequency should be 70-180 kHz. Data should be read shortly before the positive flank. The time-out between positive flanks is 20-30 μ s. The output data is 15 bits (msb first), followed by a stop bit. If SCK continues beyond the stop bit, there will be a second stop bit followed by repeated 15 bit data and a stop bit. A minimum of 120 μ s is needed after position readout to ensure refresh of position data. Reading position every 0.5 ms is the maximum recommended rate for continuous operation.

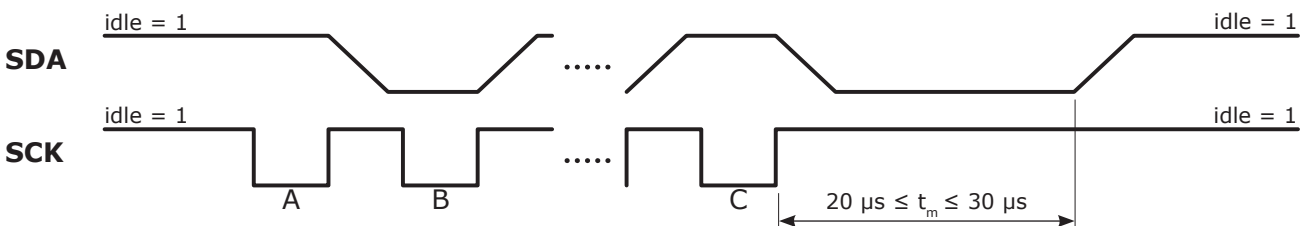

- A: 1st clock pulse, SDA stays idle until positive flank.
- B: 2nd clock pulse, SDA output is bit1 (msb).
- C: 16th clock pulse, SDA output is bit15 (lsb).

Technical Specification			
Type	LR17	Unit	Note
Diameter	17	mm	
Angular Range	360	°	continuous
Speed Range ^a	0-170	°/s	recommended, no load
Step Angle ^b	800	µrad	one wfm-step
	0.1 ^c	µrad	one microstep ^c
Motor Resolution	< 0.1	µrad	driver dependent
Encoder Type	Magnetic, absolute		SSI
Encoder Accuracy	6.3	mrاد	in a non-magnetic environment
Encoder Resolution	0.2	mrاد	32768 CPR (15 bit)
Recommended Operating Range	0-15	mNm	for best microstepping performance and life time
Stall Torque	30	mNm	
Holding Torque	> 30	mNm	
Shaft Load, Max.	1	N	- radial (6.5 mm from mounting face)
	2	N	- axial
Shaft Press Fit Force, Max.	5	N	
Maximum Voltage	48	V	
Power Consumption ^d	3.5	mW/Hz	=0.35 W at 100 Hz wfm-step frequency
Connector	CviLux CI1116M2VD0		Mates with socket CviLux CI1116S
Material in Motor Housing	Aluminium, Stainless Steel		
Weight	30	gram	approximate
Operating Temperature	0 to +50	°C	

- a. Max value is typical for waveform *Rhomb* at 2 kHz, no load, temperature 20°C.
b. Typical value for waveform *Delta*, 15 mNm torque, temperature 20°C.
c. Driver dependent; 8192 microsteps per wfm-step for driver in the PMD200-series.
d. At temperature 20°C, intermittent runs.

Note: All specifications are subject to change without notice.

Item no.

LR17-030A20E1

Family name

LR = LEGS Rotary

Diameter

17 = Ø 17 mm

Stall torque

030 = 30 mNm

Motor type

A = SS / Stainless Steel

Version

Encoder

E1 = Magnetic 15 bit SSI encoder

Connector/Cable

A00 = Connector, no cable

A15 = 1.5 m cable - does not connect to either PM driver

K15 = 1.5 m cable - for driver PMD101 and PMCM31

L15 = 1.5 m cable - for driver PMD206 and PMD236

Visit our website for application examples, CAD files, videos and more...

www.piezomotor.com



PiezoMotor Uppsala AB
Stålgatan 14
SE-754 50 Uppsala, Sweden

Telephone: +46 18 489 5000
Fax: +46 18 489 5001

info@piezomotor.com
www.piezomotor.com

