

- **Direct drive – backlash free**
- **Nanometer resolution**
- **No power draw in hold position**
- **Quick response**
- **Heavy loads**

The LTC300 motor is intended for high force and precision applications. This includes applications in vacuum for the semiconductor industry. The advantage of using the Piezo LEGS technology is the very precise positioning resolution, as well as automatic locking giving true set-and-forget performance. The technology is based on direct drive without any backlash.

The Piezo LEGS technology is characterized by its outstanding precision. Quick response time, as well as long service life are other benefits. In combination with the nanometer or even sub-nanometer resolution the technology is quite unique.

Operating modes

The motor can move in full steps (waveform-steps), or partial steps (micro-steps) giving positioning resolution in the nanometer range. Speed is adjustable from single micro-steps per second up to max specified.

Controlling the motor

PiezoMotor offers a range of drivers and controllers. The more advanced alternatives are the micro-step drivers/controllers in the 100- and 200-series. These products allow for closed loop control and precise positioning. The micro-stepping feature divides the wfm-step into thousands of small increments which results in micro-steps in the nanometer range. The PMD units are straight forward to use, supports quadrature and serial sensors, and have multiple I/O ports.



PMD101

PMD206

Design your own driver

Some customers prefer to design their own driver for ease of integration. PiezoMotor provides information to assist in the design.

Ordering information

Motor

LTC30011-020 Standard version

Drivers and Controllers

PMD101 1-axis micro-stepping driver

PMD206 6-axis micro-stepping driver

Linear Encoders

See separate data sheet

Operating Principle

The Piezo LEGS walking principle is of the non-resonant type, i.e. the position of the drive legs is known at any given moment. This assures very good control of the motion over the whole speed range.

The performance of a Piezo LEGS motor is different from that of a DC or stepper motor in several aspects. A Piezo LEGS motor is friction based, meaning the motion is transferred through contact friction between the drive leg and the drive rod. You cannot rely on each step being equal to the next. This is especially true if the motor is operated under varying loads, as shown in the diagram below. For each waveform cycle the Piezo LEGS motor will take one full step, referred to as one *wfm-step* (~6.5 µm at no load with waveform *Rhomb*). In the schematic illustrations to the right, you can see one step being completed. The velocity of the drive rod is *wfm-step* length multiplied with waveform frequency (6.5 µm x 50 Hz = 0.3 mm/s).

Micro-stepping is achieved by dividing the *wfm-step* into discrete points. The resolution will be a combination of the resolution of the D/A converter, the number of points in the waveform, and the load. Example: at 150 N load the *wfm-step* length with waveform *Delta* is ~3 µm, and with 8192 discrete points in the waveform the micro-step resolution will be ~0.4 nm.

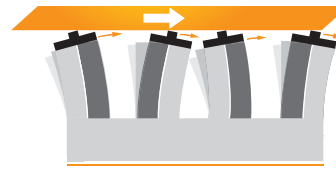

1 When all four legs are electrically activated they are elongated and bending. As we shall see below, alternate legs move as pairs. Arrows show the direction of motion of the tip of each leg.



2 The first pair of legs maintains contact with the rod and moves towards the right. The second pair retracts and their tips begin to move left.

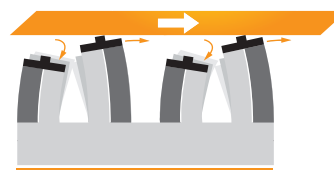

3 The second pair of legs has now extended and repositioned in contact with the rod. Their tips begin moving right. The first pair retracts and their tips begin to move left.

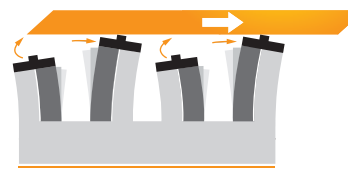

4 The second pair of legs has moved right. The first pair begins to elongate and move up towards the rod.

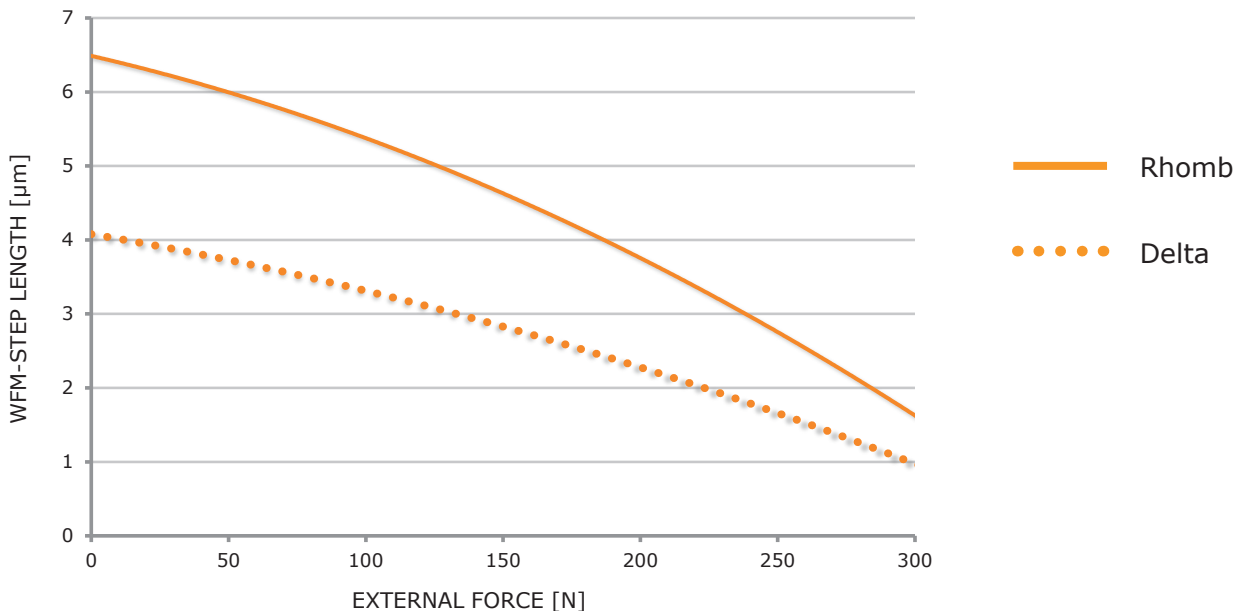
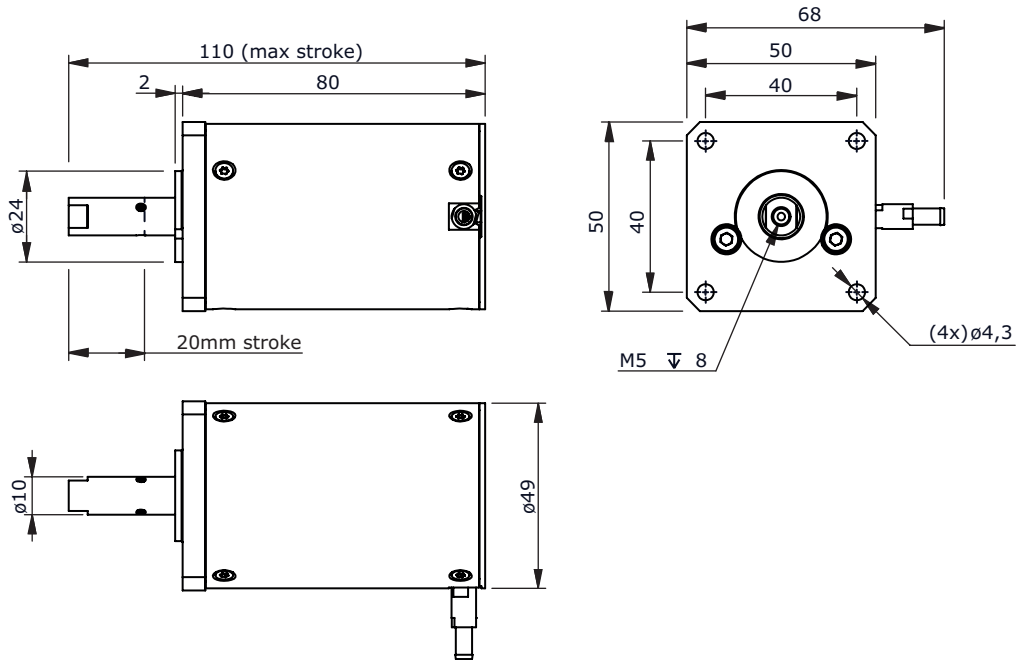

Figure 1 Motor performance with waveform *Rhomb* (filled) and waveform *Delta* (dotted). *Wfm-step* length is the average distance the drive rod moves when the legs take one *wfm-step* (i.e. for one waveform cycle). Note: Standard deviation σ of 0.5 µm should be taken into account. Typical values are given for 20°C.

Main Dimensions LTC30011-00004



Note: Refer to drawings for details.

Electrical Connector Type

Motor has multiple options for connectors depending on customer requirements. Options include LEMO connector, JST connector, or conventional D-sub type connector.

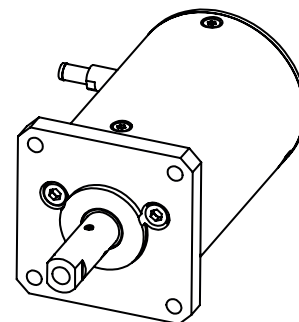
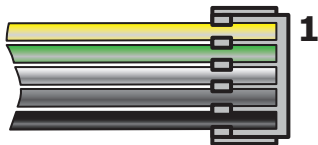

Pin Assignment

Pin	Terminal	Cable Color
1	Phase 1	Yellow
2	Phase 2	Green
3	Phase 3	White
4	Phase 4	Grey
5	Ground (GND)	Black or brown

Technical Specification			
Type	LTC30011-00004 (standard version)	Unit	Note
Maximum Stroke	20	mm	
Speed Range ^a	0-0.3	mm/s	recommended, no load
Step Length ^b	3	µm	one wfm-step
	0.0004 ^c	µm	one micro-step ^c
Resolution	< 1	nm	driver dependent
Recommended Operating Range	0-150	N	for best micro-stepping performance and life time
Stall Force	300	N	
Holding Force	> 300	N	
Maximum Voltage	48	V	
Power Consumption ^d	0.2	W/Hz	= 10 W at 50 Hz wfm-step frequency
Connector	On request		
Mechanical Size	80 x 50 x 50	mm	see drawing for details
Material in Motor Housing	Stainless Steel		
Weight	955	gram	approximate
Operating Temperature	+10 to +70	°C	

a. Max value is typical for waveform *Rhomb* at 50 Hz, no load, temperature 20°C.

b. Typical value for waveform *Delta*, 150 N load, temperature 20°C.

c. Driver dependent; 8192 micro-steps per wfm-step for driver in the PMD200-series.

d. At temperature 20°C, intermittent runs.

Note: All specifications are subject to change without notice.

Visit our website for application examples,
CAD files, videos and more...

www.piezomotor.com



PiezoMotor Uppsala AB
Stålgatan 14
SE-754 50 Uppsala, Sweden

Telephone: +46 18 489 5000
Fax: +46 18 489 5001

info@piezomotor.com
www.piezomotor.com

